

RCxx24

LED High Lumen Recessed Troffer
2x4 For Grid or Hard Ceilings



LENS OPTIONS & DELIVERED LUMENS

Part ID	Wattage	CCT	Clear Lens	LPW	Diffused Lens	LPW
12000	84	35K	12,615	150	12,581	151
12000	84	40K	12,901	154	12,916	154
12000	84	50K	13,331	159	13,251	158
17000	118	35K	17,310	147	17,047	150
17000	118	40K	17,733	150	18,102	153
17000	118	50K	18,495	157	18,377	156
19000	139	35K	20,237	146	20,115	145
19000	139	40K	20,697	149	20,572	148
19000	139	50K	21,387	154	21,228	152
24000	170	35K	24,750	146	24,601	145
24000	170	40K	25,313	149	25,161	148
24000	170	50K	26,157	154	25,840	152

Project :	
Type:	Approved By:

APPLICATIONS

Production and manufacturing facilities, schools, hospitals, multi-purpose rooms, gymnasiums, industrial recessed locations.

CONSTRUCTION

.040" white pre-painted aluminum, acrylic clear or diffused high impact D92 lens. Top access plate for quick power connection.

MOUNTING

Lay-in for grid ceilings. frame out or flange mount for hard ceilings. Consult factory for custom mounting and dimensions

SYSTEM SPECIFICATIONS

Hi flux linear LED modules, CRI > 80, CCT: 3500K, 4000K or 5000K. Constant current LED power supplies, power factor > 0.9, THD < 20%, universal voltage 120-277v, 347-480v available.

DIMMING & CONTROLS

0-10v dimming, dim to off or dim by line voltage. Integrated microwave motion sensor, wireless protocol from switch, PC or handheld device, A/B array switching, emergency driver battery back-up option.

RATINGS & WARRANTY

Temperature rated from -28°C to 50°C (-20°F to 122°F), service life > 100,000 hours (L90). CSA listed, BAA compliant. Made in the USA. 5 year product warranty. Consult factory for extended warranties.

Ordering Information

RSD						
Series	Housing	Part ID	CCT	Lens	Voltage	Dimming, EM, Controls
1st Source LED Recessed Series	RCTB24 = Lay-in For T-Bar Grid Ceiling RCFM24 = Frame Out For Hard Ceiling RCFL24 = Flange Mount For Hard Ceiling	12000 = 12,000 17000 = 17,000 19000 = 19,000 24000 = 24,000	35K 40K 50K	AC = Acrylic Clear D92 = Diffused D92 High Impact Polycarbonate Lens	U = 120-277v 3 = 347v 4 = 480v	D0 = Dim to Off D10 = Dim to 10% DLV = Dim by Line Voltage Emergency Drivers EM/2300 = 2,300L @ 16w EM/2900 = 2,900L @ 20w Controls (Consult Factory) Integrated Motion Sensor Daylight Harvesting A/B Array Switching Wireless Control System



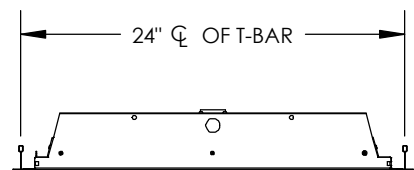
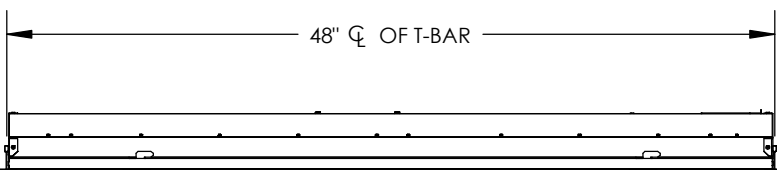
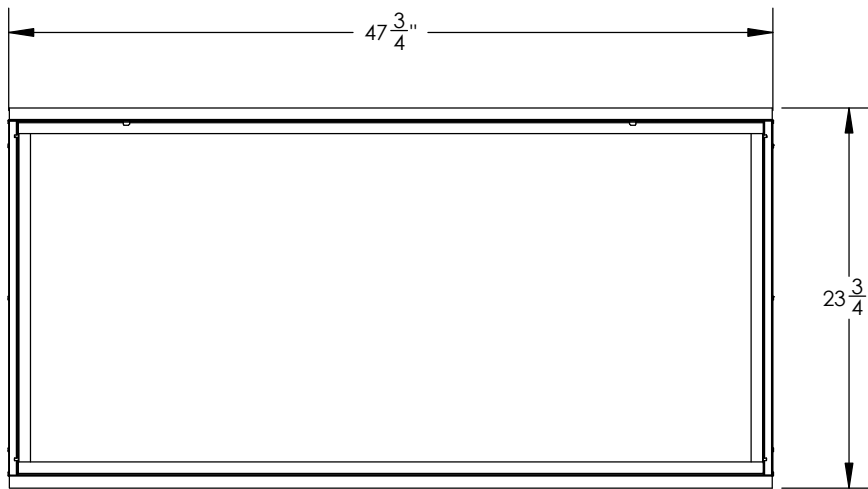
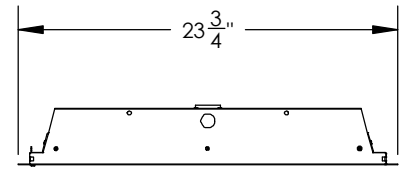
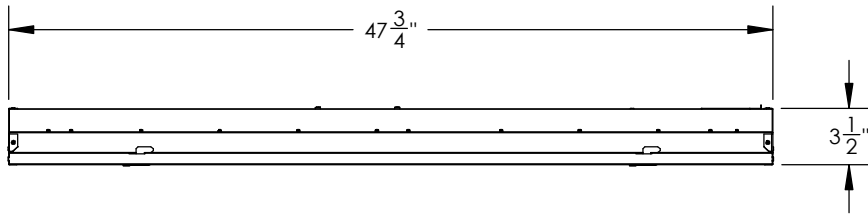

TITLE: RCTB24			
3RD ANGLE PROJ:		FILE LOCATION: \\	
UNLESS OTHERWISE NOTED:		SHEET: 1 of 1	SCALE: 1:12
SIZE: A	UNITS: INCHES GD&T ASME Y14.5M-1994	TOLERANCES: .X ±.06 .XX ±.03 .XXX ±.010 ∠ ±1.0°	DRAWN BY: JMG
		DATE: 6/29/2018	JO: XXXX
		DWG #: RCTB24 DIMENSIONS	REV: N/C

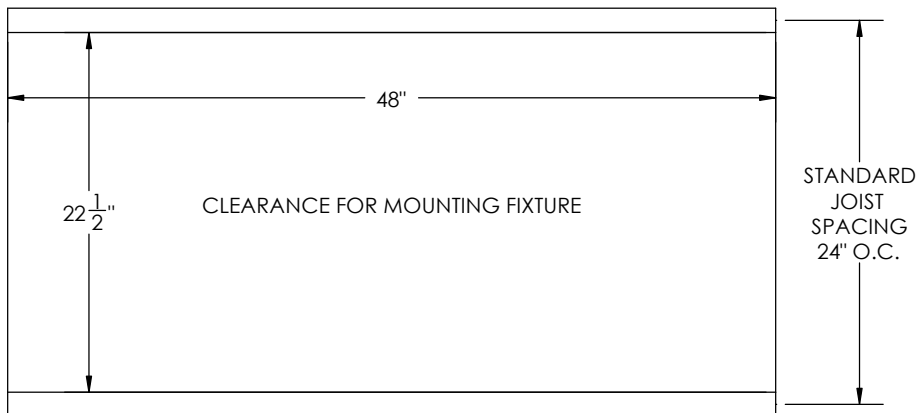
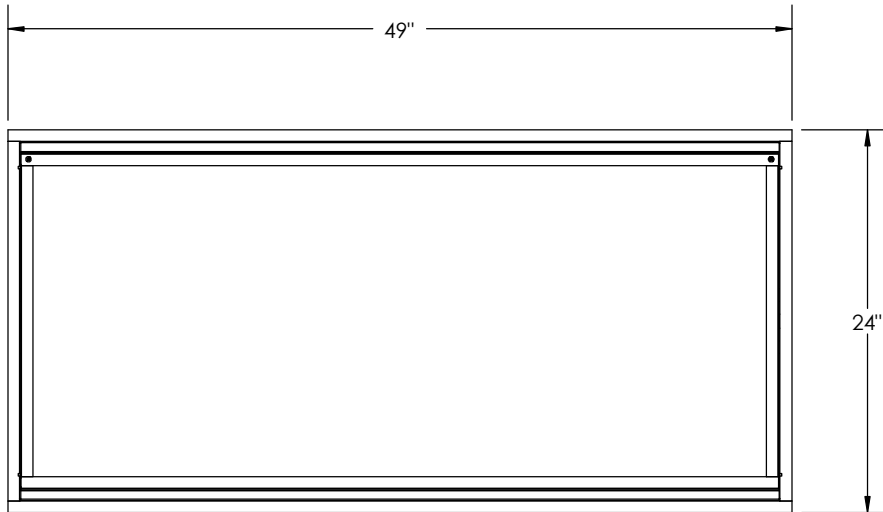
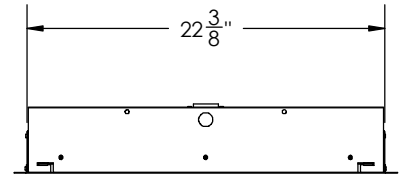
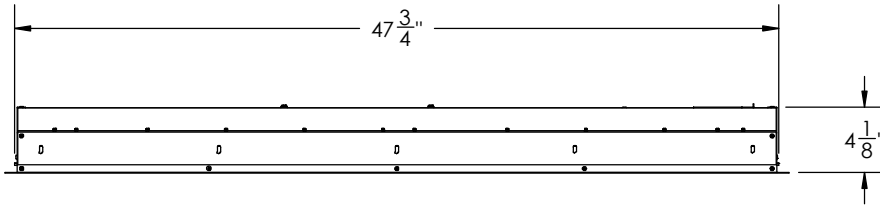

TITLE: RCFM24			
3RD ANGLE PROJ:		FILE LOCATION: \\	
UNLESS OTHERWISE NOTED:		SHEET: 1 of 1	SCALE: 1:12
SIZE: A	UNITS: INCHES GD&T ASME Y14.5M-1994	DRAWN BY: JMG	DATE: 1/16/2019
TOLERANCES: .X ±.06 .XX ±.03 .XXX ±.010 ∠ ±1.0°		DWG #: RCFM24 DIMENSIONS	JO: XXXX REV: A

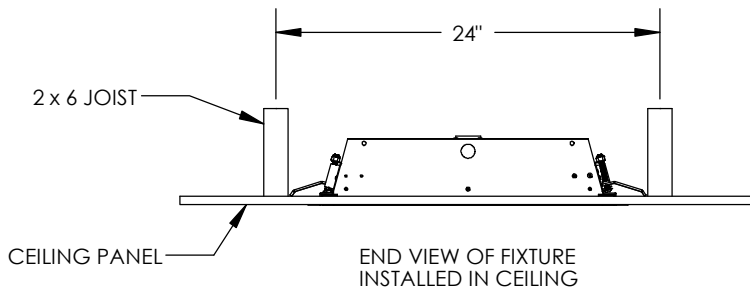
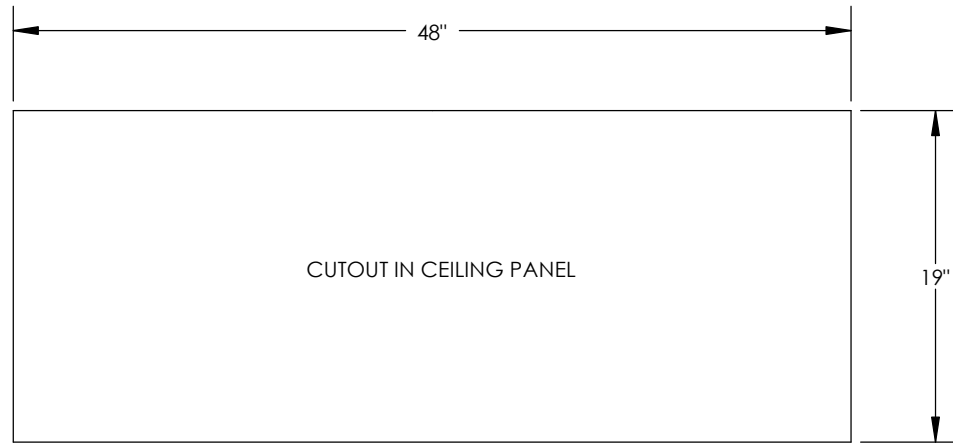
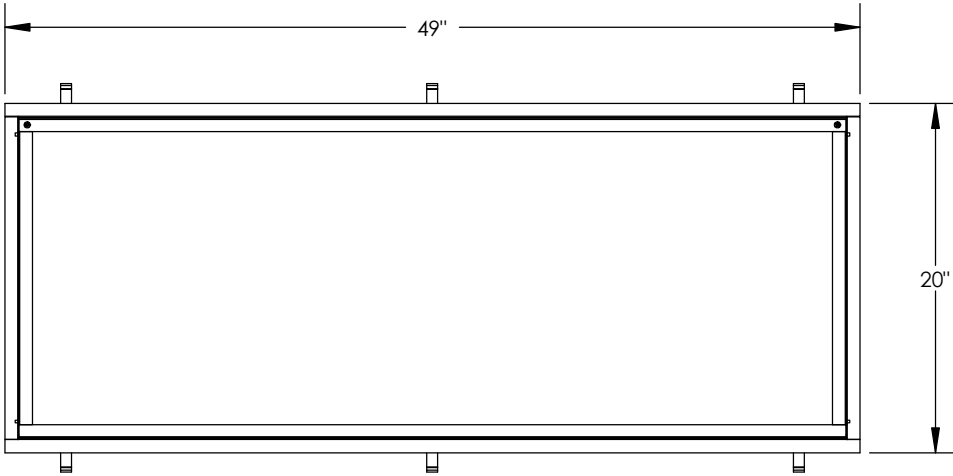
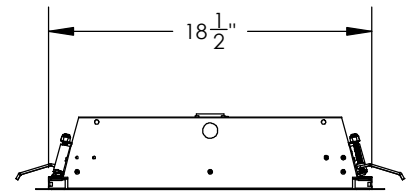
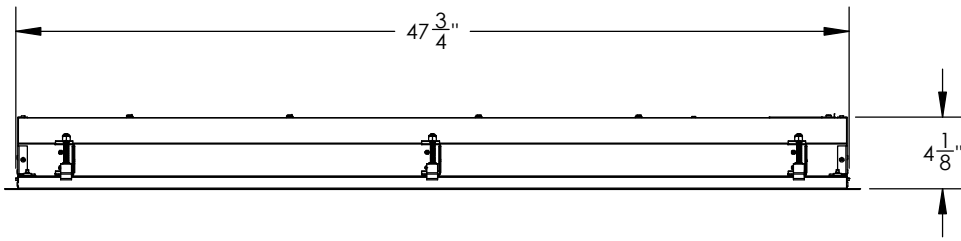

TITLE: RCFL24			FILE LOCATION: \\		
3RD ANGLE PROJ:			UNLESS OTHERWISE NOTED:		
SIZE: A	UNITS: INCHES <small>GD&T ASME Y14.5M-1994</small>	TOLERANCES: .X ±.06 .XX ±.03 .XXX ±.010 ∠ ±1.0°	SHEET: 1 of 1	SCALE: 1:11	JO: XXXX
			DRAWN BY: JMG	DATE: 6/4/2019	REV: N/C
			DWG #: RCFL24 DIMENSIONS		